

Vibro-Meter

Sensor systems for turbomachinery

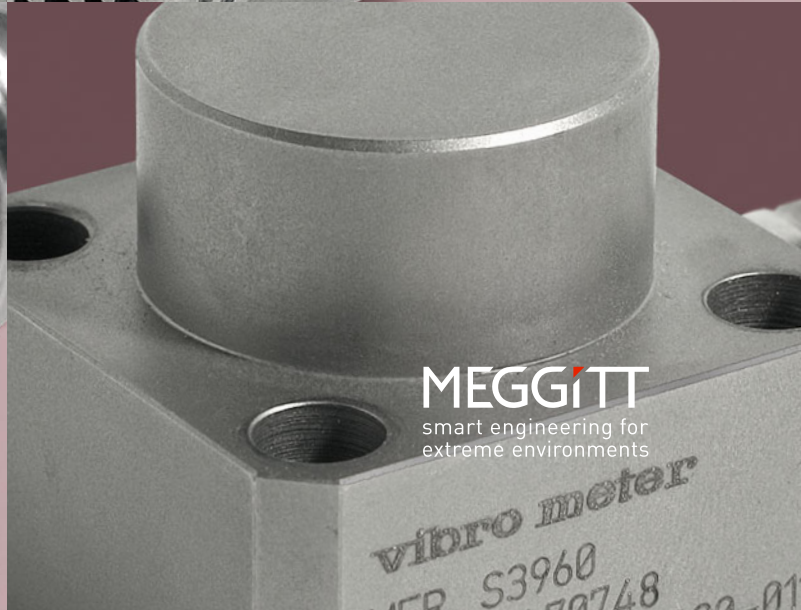
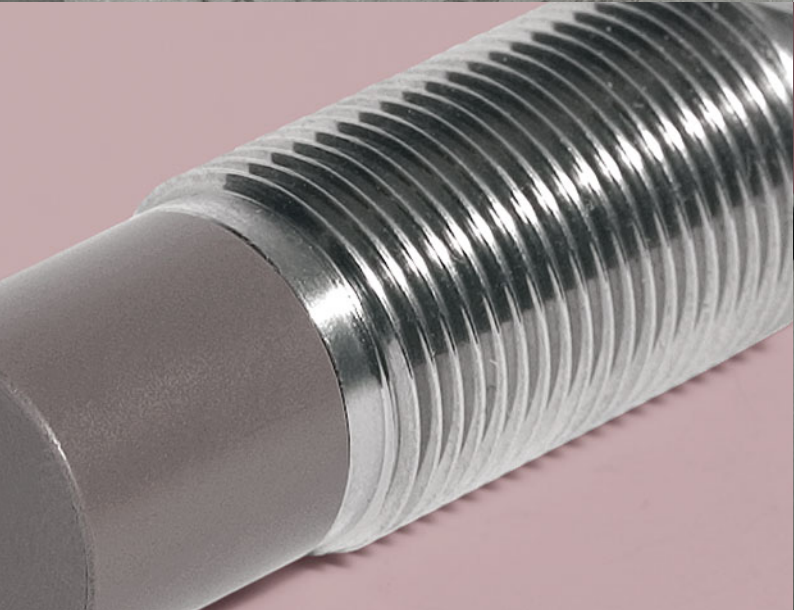
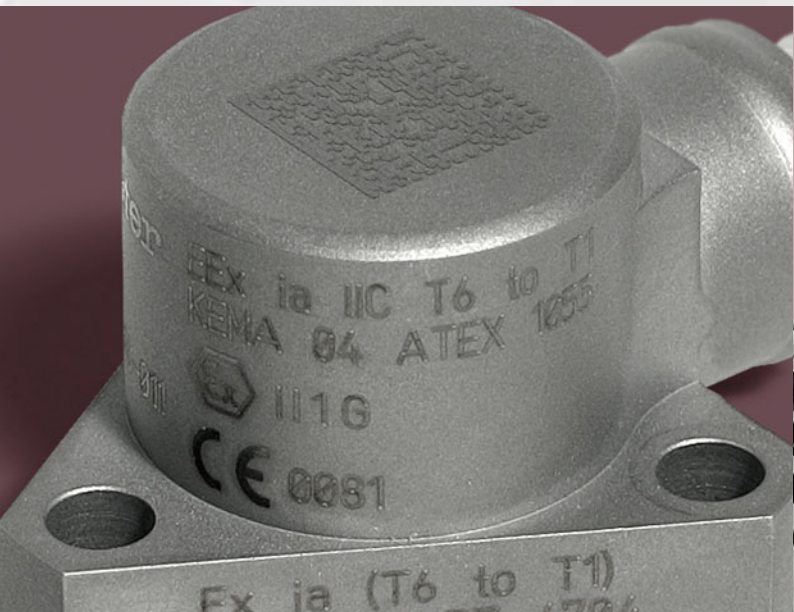

MEGGIT
smart engineering for
extreme environments

Sensor systems applications

For over 50 years, Vibro-Meter has provided superior quality vibration sensing systems to monitor critical plant and equipment.

Today, our sensor systems are successfully used in numerous industries where high capital rotating machinery represents a major asset. They protect and monitor thousands of machines worldwide:

- Heavy-duty gas turbines
- Industrial and aero-derivative gas turbines
- Steam turbines (nuclear and conventional)
- Hydro turbines
- Large generators
- Large pumps, compressors and fans
- Large electric motors and propellers

Whether your business is power generation, oil and gas production, petrochemical or marine, understanding the condition of your machinery and its mechanical behavior is necessary, to prevent failure and achieve optimum efficiency.

We make it our business to provide the best solutions for your measurement and monitoring requirements, to protect your investment. This helps you reach higher levels of reliability, machine availability and output.

Today, our highly reliable sensor systems for harsh environments are adopted by most major OEMs.



Sensor systems overview

Whether measuring dynamic pressure, acceleration or displacement, Vibro-Meter offers the most accurate, reliable and cost-effective solutions available. We have a comprehensive range of sensor systems which are standard solutions with numerous OEMs.:

CA and CE accelerometers 2 - 5



provide vibration measurements in harsh industrial conditions. We have a wide range of sensors with sensitivities from 10 to 100pC/g, for a wide range of temperatures: from standard (120°C) up to extreme (700°C). The CA series work in the most severe environments, while the CE series include conditioners and are hence more economical and simpler to integrate.

CP dynamic pressure sensors 6 - 7



are qualified by major OEMs for gas turbine combustor pulsation monitoring. The CP series use Vibro-Meter's acceleration compensation patented technology, and reach the highest sensitivity in the industry (over 750pC/bar). They have an extreme temperature capability (up to 777°C) and a very high frequency response range (up to 15 kHz). Vibro-Meter's CP sensors are key to optimizing low NO_x emissions.

TQ proximity probes 8 - 9



are eddy current transducers, for contactless measurements of relative vibration or axial displacement in turbines, alternators, turbo-compressors and centrifugal pumps. Our wide series of probes is API 670 compliant and available for high-pressure and watertight applications, with measuring ranges up to 12 mm.

CV velocity sensors 10 - 11



are widely installed on all types of low speed turbomachinery, especially hydro turbine-generator sets. The CV series measure absolute vibration down to very low frequencies, thanks to the conditioner's low frequency linearization function.

EW ice detection system 10 - 11



detects initiation of ice on gas turbines inlets. The EW system discriminates between ice and water, and optimizes the use of bleed air in gas turbine de-icing systems.

LS air gap monitoring system 10 - 11



measures the air gap between rotor and stator, using a capacitive technology. LS systems are an important indicator of machine condition in hydroelectric generators.

Complete monitoring solutions 12

Case studies 13

Our expertise 15

Accelerometers with external charge amplifiers

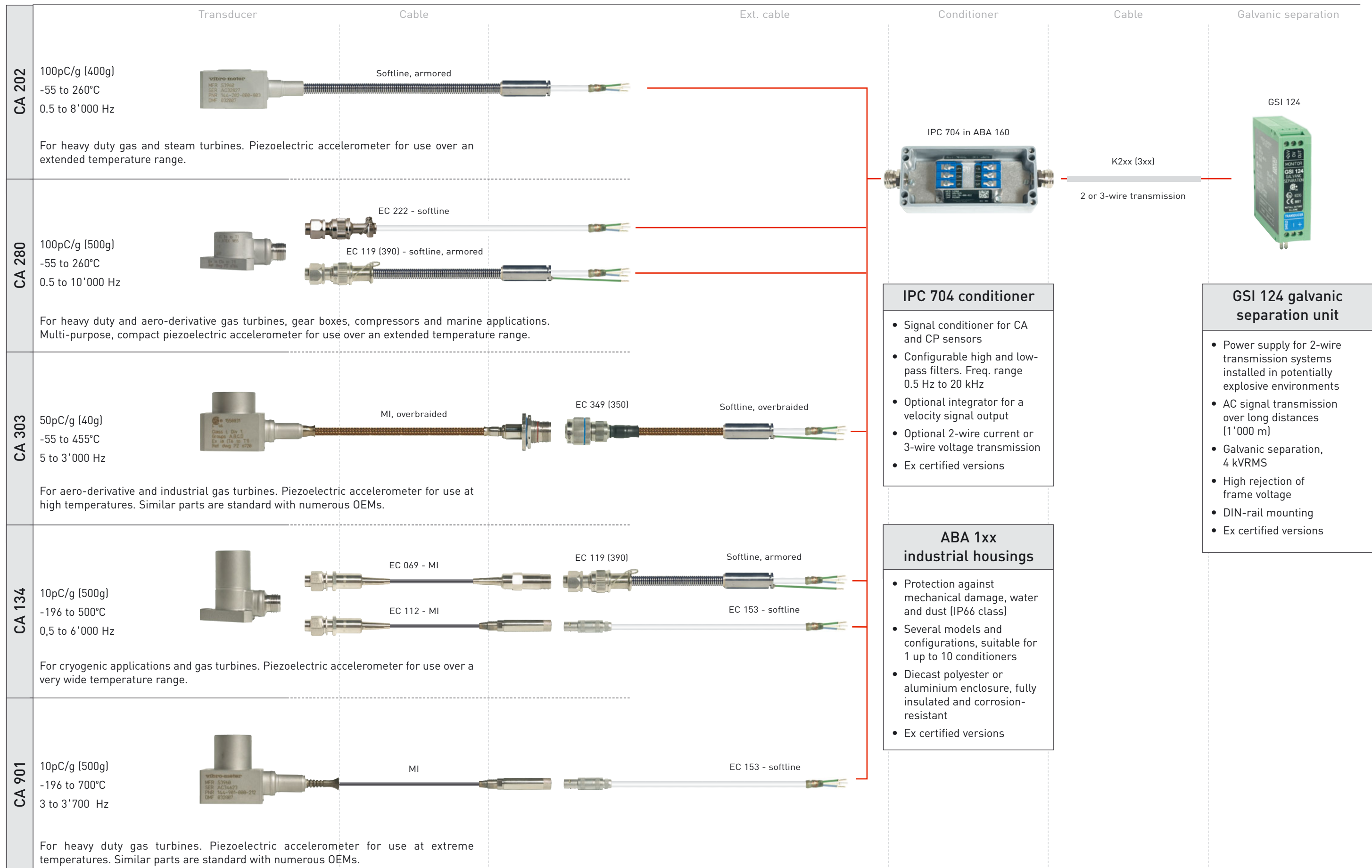

MI = Mineral integral
 Certified products versions for use in potentially explosive atmospheres are available.

Accelerometers with built-in or attached electronics

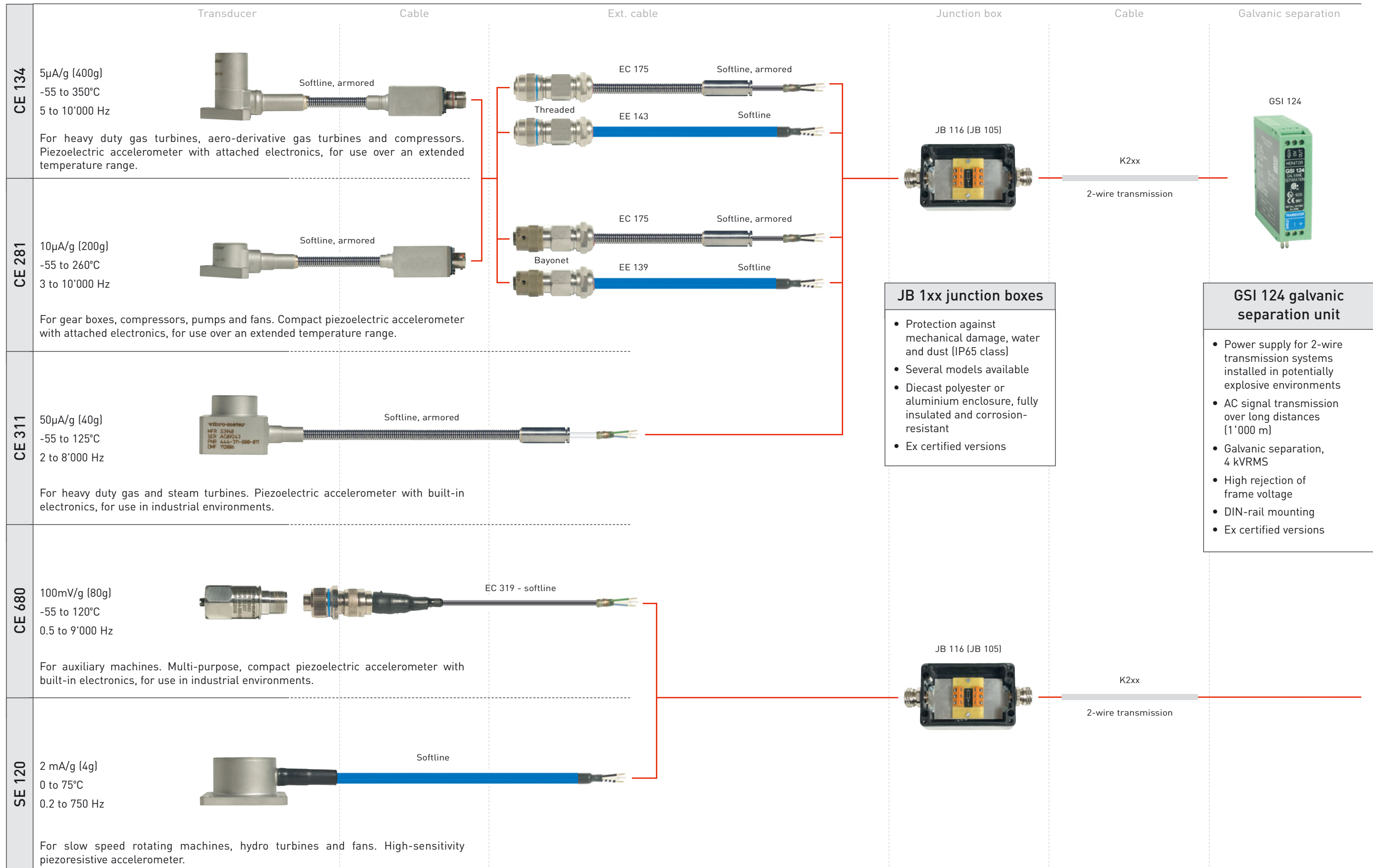

MI = Mineral integral
 Certified products versions for use in potentially explosive atmospheres are available.

Dynamic pressure sensors for combustion monitoring

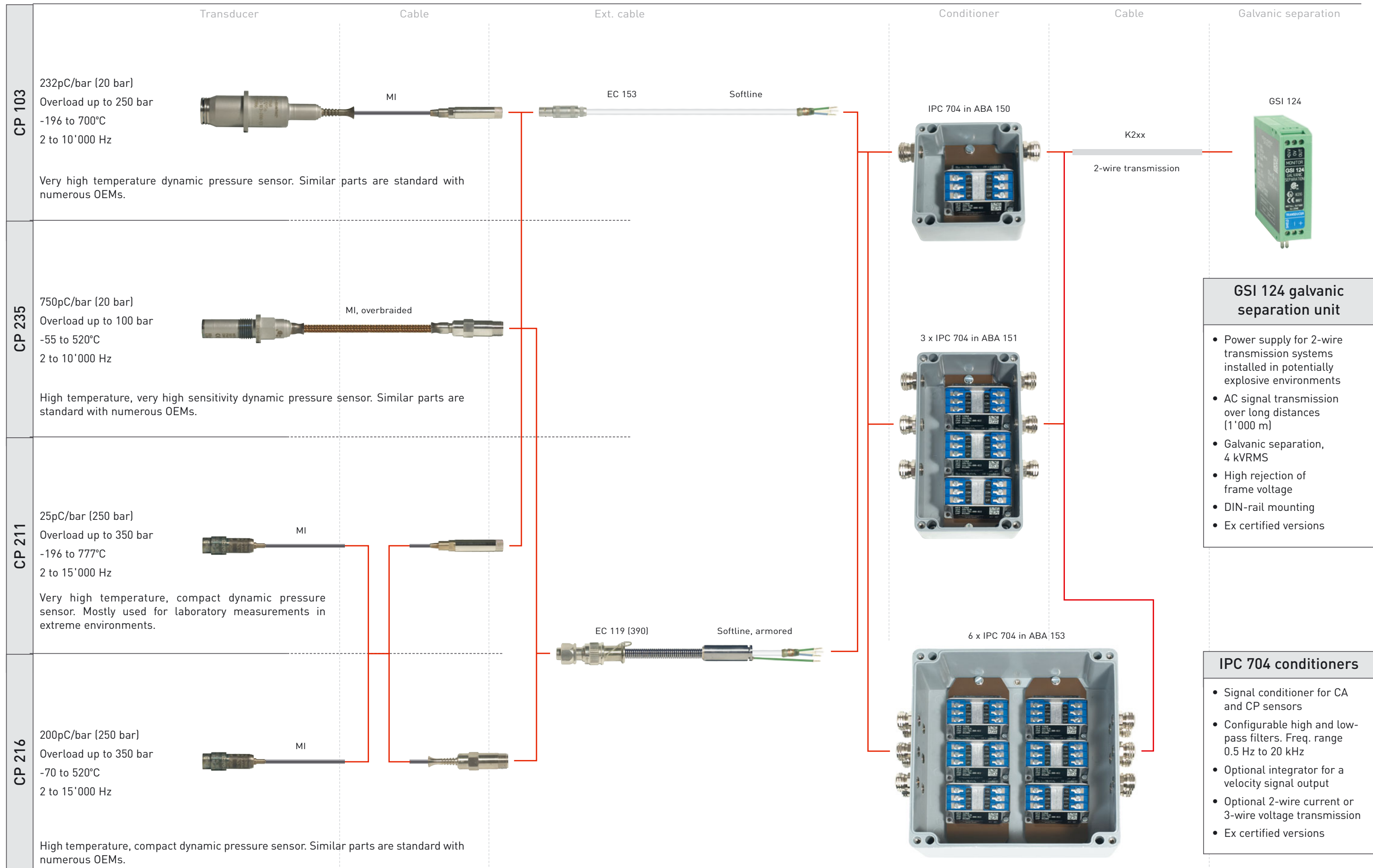

GSI 124 galvanic separation unit

- Power supply for 2-wire transmission systems installed in potentially explosive environments
- AC signal transmission over long distances (1'000 m)
- Galvanic separation, 4 kVRMS
- High rejection of frame voltage
- DIN-rail mounting
- Ex certified versions

IPC 704 conditioners

- Signal conditioner for CA and CP sensors
- Configurable high and low-pass filters. Freq. range 0.5 Hz to 20 kHz
- Optional integrator for a velocity signal output
- Optional 2-wire current or 3-wire voltage transmission
- Ex certified versions

MI = Mineral integral
Certified products versions for use in potentially explosive atmospheres are available.

Proximity probes for all displacement measurements

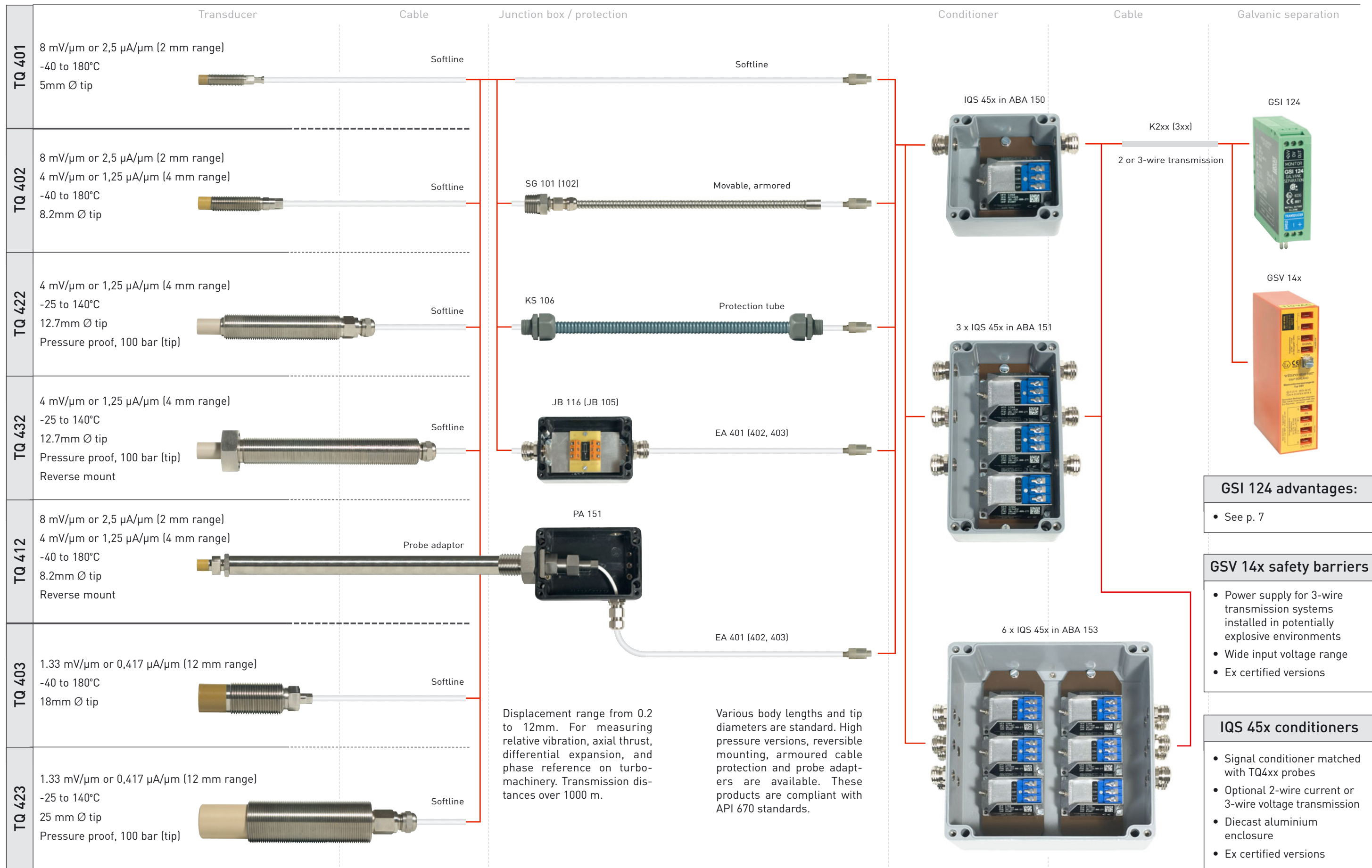

GSI 124 advantages:

- See p. 7

GSV 14x safety barriers

- Power supply for 3-wire transmission systems installed in potentially explosive environments
- Wide input voltage range
- Ex certified versions

IQS 45x conditioners

- Signal conditioner matched with TQ4xx probes
- Optional 2-wire current or 3-wire voltage transmission
- Diecast aluminium enclosure
- Ex certified versions

All "softline" cables can be delivered in armored version.

Velocity sensors

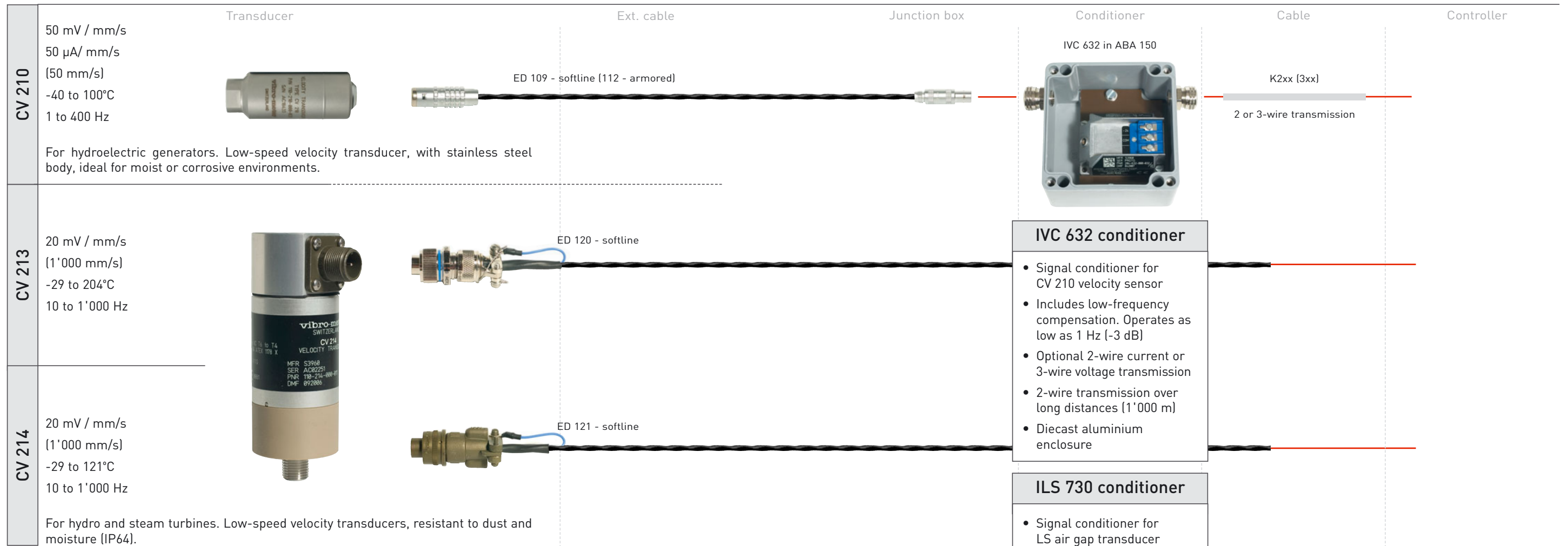

Ice detection system

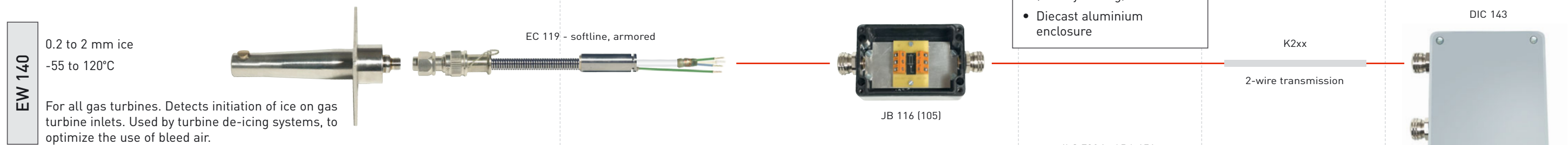

Air gap monitoring system

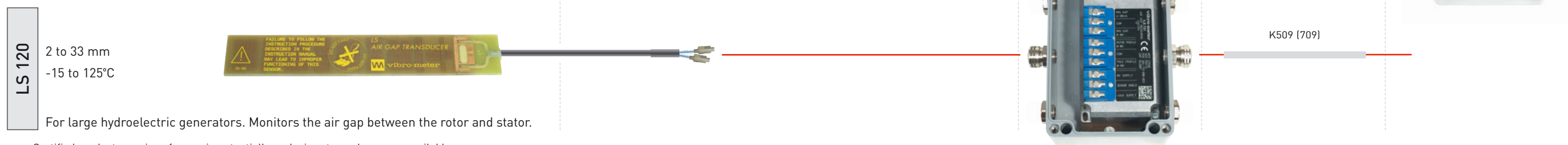

Certified products versions for use in potentially explosive atmospheres are available.

Complete monitoring solutions

Sensors, protection, condition and performance monitoring

The VM600 series is a state of the art machinery monitoring solution: it provides protection and condition monitoring systems under-pinned by machinery diagnostics, installation and training support. This powerful system for machinery monitoring is based upon 50 years of experience in the design and manufacture of sensors and monitoring systems for industrial and aerospace applications.



VM600

Flexible, powerful and versatile, a VM600 installation can start small and grow in size and capability as your needs evolve. This complete system from a single supplier covers all your machinery condition and performance monitoring requirements.

VM600 scalability:

- Stand-alone machinery protection monitor
- Optional communications through network or modem
- Remote support and maintenance
- Condition monitoring data acquisition
- Performance monitoring data acquisition
- Simple storage and trending software
- Fully featured condition monitoring software
- Simple and advanced performance monitoring
- Multi-site, multi-user access

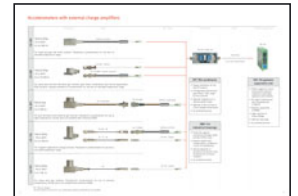

CA sensors, p. 2 - 3

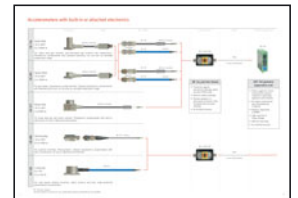

CE sensors, p. 4 - 5

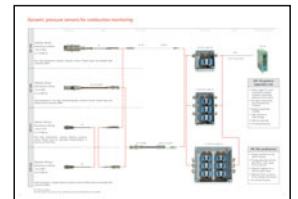

CP sensors, p. 6 - 7

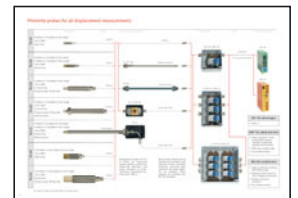

TQ sensors, p. 8 - 9



CV, EW, LS sensors, p. 10 - 11



Client applications PC



Distributed Control System for processing data



Electronic Shutdown System



Vibro-Meter's remote support PC

Case studies

Heavy duty gas turbine: Siemens SGT5-4000F

Combustion and vibration monitoring (CP and CA sensors, with VM600)

The SGT5-4000F (V94.3A) dry-low NO_x Gas Turbine (GT) is one of the most powerful in operation, designed for large-scale applications with more than 280 MW ISO output. Vibro-Meter is the exclusive supplier of protection & monitoring equipment for this GT, Siemens' proven workhorse, with more than three hundred units in operation worldwide.

One of the major industrial challenges with heavy-duty GTs is to combine the highest possible efficiency with extremely low NO_x emissions and low combustion temperatures. Measuring the dynamic pressure at different locations in the combustor is a proven way to control combustion. Thus, pulsation monitoring systems are essential both during the GT tuning and operation.

The sensors and monitoring equipment provided by Vibro-Meter allow Siemens to control combustion parameters such as fuel injection, which leads to extremely low emissions, reduced fuel consumption and long intervals between major inspections. Our sensing and monitoring systems on the SGT5-4000F include extreme temperature dynamic pressure sensors (CP 216), high sensitivity piezoelectric accelerometers (CA 201 and CA 901) and protection and monitoring systems (VM 600).

Vibro-Meter is proud to have contributed to making the SGT5-4000F one of the most efficient available for power generation applications.

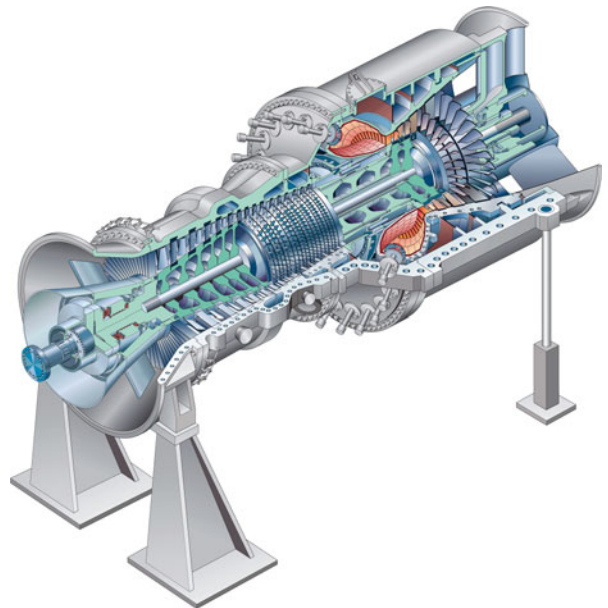

SGT5-4000F
(copyright Siemens AG)

Hydro turbine-generator: Shipshaw Hydro Power Plant (Canada)

Air gap and vibration monitoring (LS and CA sensors, with VM600)

Shipshaw Hydro Power Plant (HPP) is owned by the largest independent producer of hydroelectricity in Quebec, Alcan Energie Electrique. At the time of construction, the power plant was the most powerful in the world, with an output of 896 MW.

Condition monitoring of hydroelectric generators is critically important, especially the monitoring of the distance between the rotor poles and the stator walls, called air gap. To increase efficiency in generators, the air gap is reduced to a minimum. However, both the stator and the rotor on large hydroelectric machines can be quite flexible and their shape and location are affected in operation by centrifugal, thermal, and magnetic forces.

This means that the air gap can only be effectively measured whilst the generator is in service. In the absence of effective monitoring, efficiency would decrease and potential machine damage could occur.

In Shipshaw HPP, this issue is solved by using Vibro-Meter's air gap measuring systems (LS 120 and ILS 730). Furthermore, our piezoelectric vibration measurement chains (CA 202 and IPC 704) monitor the bearings broad-band absolute vibration at the generator and turbine. VM 600 protection and condition monitoring systems provide an overall data overview used for plant diagnostics and management.

Balance-of-plant: Yonghung Thermal Power Plant (South Korea) Proximity, displacement and vibration monitoring (TQ and CE sensors, with VM600)

Yonghung is the largest coal fired power plant in south Korea. Each 870 MW supercritical unit is designed for variable pressure operation at 3'600 RPM and 560 °C. Yonghung is designed with the philosophy of preserving the environment using a two stage combustion with low-NO_x burners followed by selective catalytic reduction.

To ensure efficient plant operation and to achieve their environmental objectives, Yonghung TPP (units 3 & 4) has 22 VM600 protection and condition monitoring systems, managing over 400 dynamic measurement points per unit. These sensors systems are provided by Vibro-Meter to secure and monitor a variety of machines for the steam turbine and the balance-of-plant in Yonghung. These include: BFP (Boiler Feed water Pump) Turbine, BFP Motor, Forced Daft Fans, Primary Air Fans, Condensate Pumps (Booster and Water), blowers and air compressors.

At Yonghung TPP, Vibro-Meter's highly reliable sensors for harsh environments measure a range of vibration and displacement characteristics. Proximity probes (TQ 402) and

piezoelectric accelerometers (CE 680) measure shaft position, relative shaft vibration (x-y), rotational speed of shaft and bearing broadband absolute vibration. Furthermore, Vibro-Meter sensors on the primary air fan enable the pre-heater system to use hot air to remove moisture from coal before the combustion process, which reduces NO_x emissions. The VM 600 protection & condition monitoring systems then processes the signals, and provide an overall data overview: this is necessary to maintain an efficient plant operation through diagnostics and plant health management.



Yonghung TPP (courtesy of Vibro Korea)

Early detection of air gap anomalies using the equipment provided by Vibro-Meter enables condition monitoring of Shipshaw hydro-electric generators. As a result, plant efficiency is optimized, generator damage can be avoided and operators can more efficiently predict and plan maintenance outages.



*Shipshaw HPP
(courtesy of Alcan Canada)*

Our expertise

Engineering

Thanks to its experienced engineers and experts, Vibro-Meter's R&D department provides our customers with the latest technology in sensing systems for turbomachinery, often used in harsh environments.

Vibro-Meter has ongoing collaborations with several renowned universities and institutes of technology. As a result of our continuous innovative effort, we own a range of patents, guaranteeing the uniqueness of our technology and know-how.

We maintain our cutting edge by using modern tools, in-house developed software and top-notch simulation and design software such as Matlab®, Simulink®, Cadence®, Allegro® and Solidworks® among others.

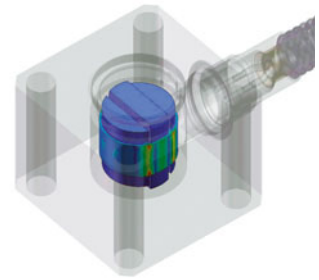

Manufacturing

Vibro-Meter's large and modern manufacturing facility in Fribourg (Switzerland) is designed to ensure the highest quality standards and organized to efficiently produce large scale orders as well as small batches. Already in the 80's, we introduced our first Production Planning System, to reach high quality and productivity objectives.

Sensors are manufactured from a large number of miniature, precisely-machined parts. Our experts use CNC-based equipment for precision machining, vacuum annealing, vacuum welding, argon arc welding and electron beam welding, among other techniques. To produce our electronic sub-assemblies, we invested into fully-programmable SMD assembly lines and automatic visual inspection equipment.

As a 21st century high-tech international organization, we are concentrating on strategic manufacturing processes, with the aim of increasing added value, from the point of view of the customer.



Quality management

The quality and reliability of Vibro-Meter's products have been widely recognized by customers for many years. Following our entry into the aviation sector in the 70's, a Quality System was put in place so that we could be certified by the associated customers and certifying bodies. Vibro-Meter was first certified ISO9000 in 1995 and has been recertified regularly since then. Our latest BS EN ISO9001:2000 certification has been awarded in April 2007.

Today, we have a very large team of experts working for quality assurance, ensuring the quality of engineering and software, the standardisation, the calibration of equipment, qualification tests and certification.

Our quality policy applies to everything we undertake. All employees strive to consistently develop, maintain and improve our quality management system at every opportunity. External as well as internal customers are the focus of everything we do.



Since its foundation in 1952 in Fribourg, Switzerland, Vibro-Meter has been supplying reliable, high quality instrumentation systems for aviation, marine and industrial customers worldwide. As a major company in the Meggitt group, we are in a strong position to pursue our aims, offering total condition monitoring on land, sea and air.

Our quality policy is one of the basic keys to the success of our company. The priority given to the needs and expectations of our customers, and the importance we attribute to technical innovation and the quality of our personnel, all contributes to our company's reputation.

Our aerospace division is the leading supplier of vibration, speed, pressure and ice detection systems for civil and military applications.

Our industrial and marine division supplies complete monitoring solutions for turbomachinery applications. Products include a comprehensive range of transducers and associated hardware and total condition and performance monitoring systems. The principal parameters monitored are:

- vibration
- displacement
- dynamic pressure
- velocity

Our international network of subsidiaries and distributors is never far away to provide assistance and technical support.

Vibro-Meter is a Meggitt group company. Headquartered in the UK, Meggitt PLC is an international group of companies operating in North America, Europe and Asia. Known for its specialist extreme environment engineering, Meggitt is a world leader in the aerospace, defence and electronics industries.

All information in this brochure is ©Vibro-Meter SA and is subject to modification without previous notice. Version 1.0 - 06.2007

Vibro-Meter

Vibro-Meter SA
Route de Moncor 4
PO Box
CH - 1701 Fribourg
Switzerland

Tel: +41 (0)26 407 11 11
Fax: +41 (0)26 407 13 01
info@vibro-meter.com

www.vibro-meter.com

www.meggitt.com

MEGGITT
smart engineering for
extreme environments